

IN1488

Quadruple Line Drivers

The IN1488 is a monolithic quadruple line driver designed to interface data terminal equipment with data communication equipment in conformance with the specifications of EIA standard RS-232C.

- Meets specifications of EIA RS-232C
- Current limited output ± 10 mA Typical
- Power-off output impedance 300Ω Min
- Simple slew rate control by load capacitor
- Flexible operating supply range
- Input are TTL and DTL circuits compatible

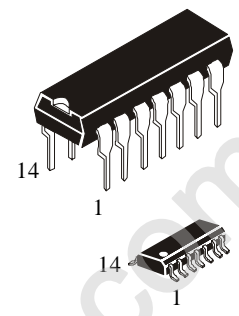

N SUFFIX
PLASTIC

D SUFFIX
SOIC

ORDERING INFORMATION
IN1488N Plastic
IN1488D SOIC

$T_A = 0^\circ$ to 70° C for all packages.

LOGIC DIAGRAM

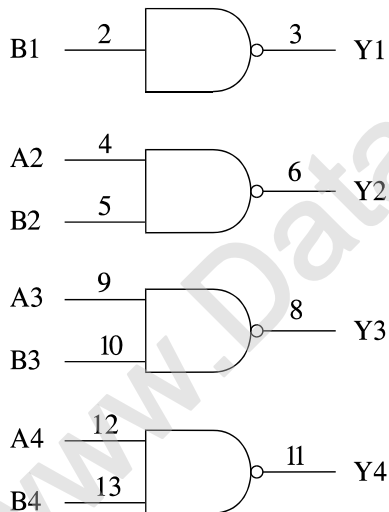

PIN 1 = V_S
PIN 14 = V_{EE}
PIN 7 = GND

PIN ASSIGNMENT

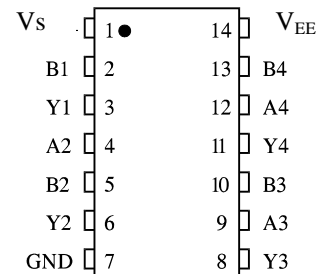

FUNCTION TABLE

Inputs		Output
A	B	Y
H	H	L
L	X	H
X	L	H

X - don't care

MAXIMUM RATINGS*

Symbol	Parameter	Value	Unit
V_S	Supply Voltage	15	V
V_{EE}	Supply Voltage	- 15	V
V_I	Input Voltage Range	- 15 to 7	V
V_O	Output Voltage Range	-15 to 15	V
P_T	Continuous Total Dissipation at (or below) 25°C	1	W
Tstg	Storage Temperature Range	-65 to 150	°C

* Maximum Ratings are those values beyond damage to the device may occur. Functional operating should be restricted to the Recommended Operating Conditions.

RECOMMENDED OPERATING CONDITIONS

Symbol	Parameter	Min	Max	Unit
V_S	Supply Voltage		15	V
V_{EE}	Supply Voltage	-15		V
V_{IL}	Low Level Input Voltage	1.9		V
V_{IH}	High Level Input Voltage		0.8	V
T_A	Operating Temperature, All Package Types	-10	70	°C

DC ELECTRICAL CHARACTERISTICS ($T_A = -10^{\circ}\text{C}$ to 70°C)

Symbol	Parameter	Test Conditions		Guaranteed Limits		Unit
				Min	Max	
V_{OH}	High-Level Output Voltage	$V_{IL}=0.8\text{V}$ $R_L=3\text{k}\Omega$	$V_S=9\text{V}$ $V_{EE}=-9\text{V}$	6		V
			$V_S=13.2\text{V}$ $V_{EE}=13.2\text{V}$	9		
V_{OL}	Low-Level Output Voltage	$V_{IH}=1.9\text{V}$ $R_L=3\text{k}\Omega$	$V_S=9\text{V}$ $V_{EE}=-9\text{V}$	-6		V
			$V_S=13.2\text{V}$ $V_{EE}=-13.2\text{V}$	-9		
I_{IH}	High-Level Input Current	$V_I=5\text{V}$ $V_S=9\text{V}, V_{EE}=-9\text{V}$			10	μA
I_{IL}	Low-Level Input Current	$V_I=0\text{V}$ $V_S=9\text{V}, V_{EE}=-9\text{V}$			-1.6	mA
I_{OS}^*	Short-Circuit Output Current at High Level	$V_I=0.8\text{V}$ $V_O=0\text{V}$ $V_S=9\text{V}, V_{EE}=-9\text{V}$		-6	-12	mA
I_{OS}^*	Short-Circuit Output Current at Low Level	$V_I=1.9\text{V}$ $V_O=0\text{V}$ $V_S=9\text{V}, V_{EE}=-9\text{V}$		6	12	mA
r_o	Output Resistance, power off	$V_S=0\text{V}, V_{EE}=0\text{V}$ $V_O=-3\text{V}$ or 3V		300		Ω
I_{OC+}	Supply Current from V_S	$V_S=9\text{V},$	All inputs at 1.9V		20	mA
			All inputs at 0.8V		6	
		$V_S=12\text{V}$	All inputs at 1.9V		25	
			All inputs at 0.8V		7	
		$V_S=15\text{V}$ $T_A=25^{\circ}\text{C}$	All inputs at 1.9V		34	
			All inputs at 0.8V		12	
I_{OC-}	Supply Current from V_{EE}	$V_{EE}=-9\text{V},$	All inputs at 1.9V		-17	mA
			All inputs at 0.8V		-0.015	
		$V_{EE}=-12\text{V}$	All inputs at 1.9V		-23	
			All inputs at 0.8V		-0.015	
		$V_{EE}=-15\text{V}$ $T_A=25^{\circ}\text{C}$	All inputs at 1.9V		-34	
			All inputs at 0.8V		-2.5	

* Not more than one output should be shorted at a time

AC ELECTRICAL CHARACTERISTICS($V_S = 9V, V_{EE} = -9V, T_A = 25^\circ C, t_r = t_f = 5ns$)

Symbol	Parameter	Test Condition	Guaranteed Limits		Unit
			Min	Max	
t_{PLH}	Propagation Delay Time, Low-to-High-Level Output	$R_L=3k\Omega, C_L=15pF$ See Figure 1		350	ns
t_{PHL}	Propagation Delay Time, High-to-Low-Level Output			175	ns
t_{TLH}	Transition Time, Low-to-High-Level Output *			100	ns
t_{THL}	Transition Time, High-to-Low-Level Output *			75	ns

* Measured between 10% and 90% points of output waveform.

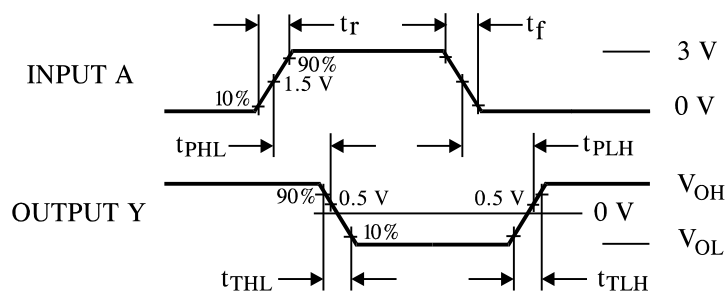
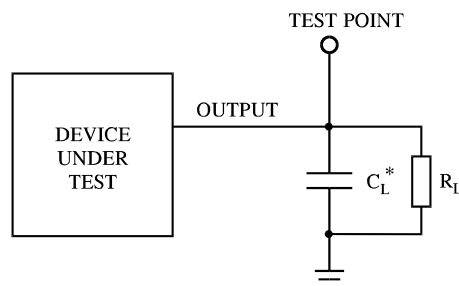

Figure 1. Switching Waveforms



* Includes all probe and jig capacitance

Figure 2. Test Circuit

**N SUFFIX PLASTIC DIP
(MS - 001AA)**

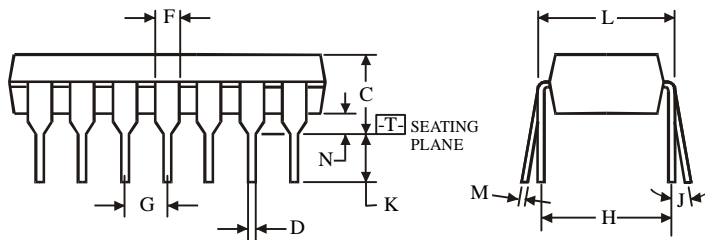
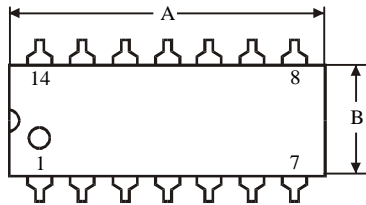
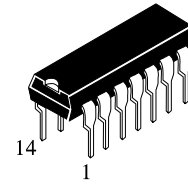

$\oplus 0.25 (0.010) \text{ (M) T}$

NOTES:

- Dimensions "A", "B" do not include mold flash or protrusions.
Maximum mold flash or protrusions 0.25 mm (0.010) per side.

Symbol	Dimension, mm	
	MIN	MAX
A	18.67	19.69
B	6.1	7.11
C		5.33
D	0.36	0.56
F	1.14	1.78
G	2.54	
H	7.62	
J	0°	10°
K	2.92	3.81
L	7.62	8.26
M	0.2	0.36
N	0.38	

**D SUFFIX SOIC
(MS - 012AB)**

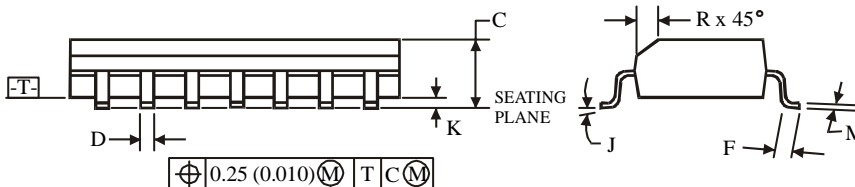
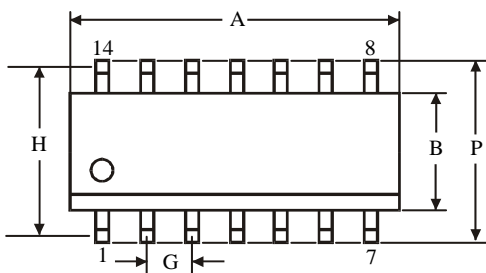
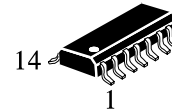

$\oplus 0.25 (0.010) \text{ (M) T C (M)}$

NOTES:

- Dimensions A and B do not include mold flash or protrusion.
- Maximum mold flash or protrusion 0.15 mm (0.006) per side for A; for B - 0.25 mm (0.010) per side.

Symbol	Dimension, mm	
	MIN	MAX
A	8.55	8.75
B	3.8	4
C	1.35	1.75
D	0.33	0.51
F	0.4	1.27
G	1.27	
H	5.27	
J	0°	8°
K	0.1	0.25
M	0.19	0.25
P	5.8	6.2
R	0.25	0.5